

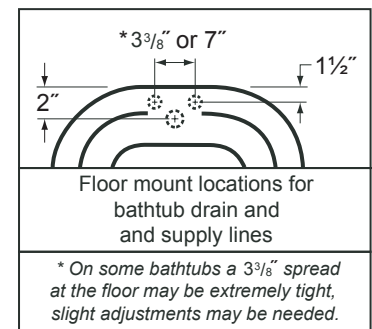

**Overall Dimensions:** 60" L x 30" W x 24" H

**Capacity:** 40 Gallons

**Weight:** Dry wt. = 140 lbs.  
Full wt. = 474 lbs.

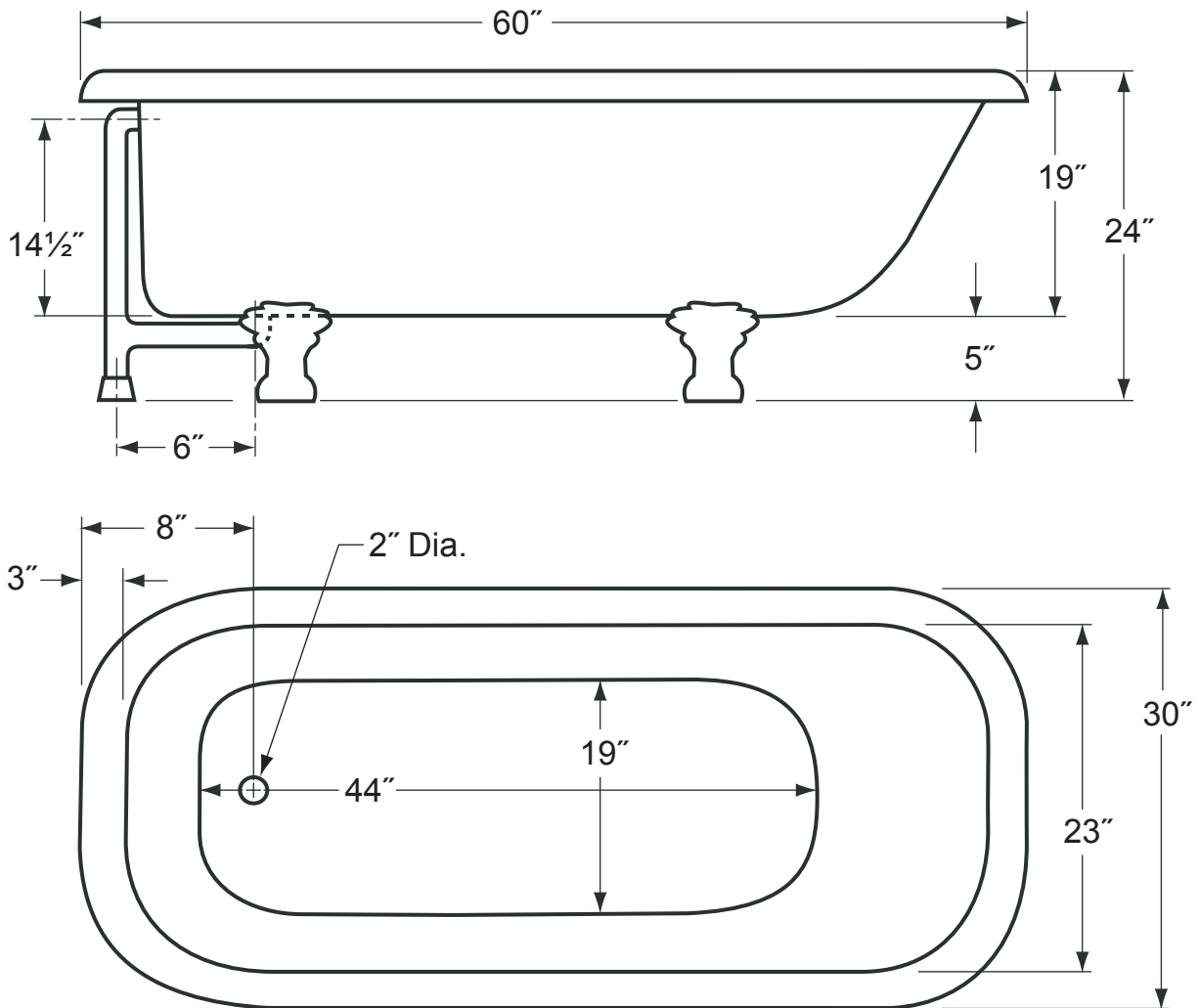

- The illustration above is shown with the standard Waste & Overflow.
- Dimensions shown have a tolerance of  $\pm 1/2$ ". Dimensions shown not to scale.
- See Clawfoot Guide (included with tub) for detailed installation instructions.

